

GPS TIME STEERING

W. J. Klepczynski
U. S. Naval Observatory

H. F. Fliegel
The Aerospace Corporation

D. W. Allan
National Bureau of Standards

ABSTRACT

The importance of the Global Positioning System (GPS) for global time transfer makes it desirable to steer GPS time as closely as possible to the UTC rate. Currently, GPS time is maintained to satisfy two system requirements. First, GPS time is steered to within one microsecond of UTC(USNO) when the leap seconds imposed on UTC since 1980 have been removed. Second, the GPS Navigation Message gives the offset UTC(USNO) - GPS time to users with an error not to exceed 100 nanoseconds. User performance would be improved, however, if changes in the GPS time rate were smaller and more gradually imposed than at present. Three current developments are expected to improve GPS time steering performance: the installation of a stable clock ensemble at the GPS Master Control Station; improvement of supporting hardware; and application of control theory to steering procedures.

INTRODUCTION

The Global Positioning System (GPS) for navigation and time transfer is currently in the development phase, and must pass through a number of well-defined checkpoints before becoming operational. Important concerns which are presently the focus of management attention include the following:

- 1) the delay in deploying the full constellation of Block II Navstar satellites, in the wake of the setback to the Space Transportation System;
- 2) the question whether the Block I satellites now operating will continue to be useful, since several are long past the five year lifetime for which they were designed;
- 3) the difficulty of testing and proving the ground control hardware and software with the limited constellation of satellites now available.

Nevertheless, GPS has been astonishingly successful for its nonmilitary users in providing an accurate and reliable means of global time transfer. For several years, synchronization experiments between the US National Bureau of Standards (NBS) and other laboratories, and the international timekeeping center at the Paris Observatory, have been performed using the GPS with reported accuracy of 20 nanoseconds, using the

Report Documentation Page

*Form Approved
OMB No. 0704-0188*

Public reporting burden for the collection of information is estimated to average 1 hour per response, including the time for reviewing instructions, searching existing data sources, gathering and maintaining the data needed, and completing and reviewing the collection of information. Send comments regarding this burden estimate or any other aspect of this collection of information, including suggestions for reducing this burden, to Washington Headquarters Services, Directorate for Information Operations and Reports, 1215 Jefferson Davis Highway, Suite 1204, Arlington VA 22202-4302. Respondents should be aware that notwithstanding any other provision of law, no person shall be subject to a penalty for failing to comply with a collection of information if it does not display a currently valid OMB control number.

1. REPORT DATE DEC 1986	2. REPORT TYPE	3. DATES COVERED 00-00-1986 to 00-00-1986			
4. TITLE AND SUBTITLE GPS Time Steering		5a. CONTRACT NUMBER			
		5b. GRANT NUMBER			
		5c. PROGRAM ELEMENT NUMBER			
6. AUTHOR(S)		5d. PROJECT NUMBER			
		5e. TASK NUMBER			
		5f. WORK UNIT NUMBER			
7. PERFORMING ORGANIZATION NAME(S) AND ADDRESS(ES) U.S. Naval Observatory, 3450 Massachusetts Avenue, NW, Washington, DC, 20392-5420		8. PERFORMING ORGANIZATION REPORT NUMBER			
9. SPONSORING/MONITORING AGENCY NAME(S) AND ADDRESS(ES)		10. SPONSOR/MONITOR'S ACRONYM(S)			
		11. SPONSOR/MONITOR'S REPORT NUMBER(S)			
12. DISTRIBUTION/AVAILABILITY STATEMENT Approved for public release; distribution unlimited					
13. SUPPLEMENTARY NOTES Proceedings of the Eighteenth Annual Precise Time and Time Interval (PTTI) Applications and Planning Meeting, Washington, DC, 2-4 Dec 1986					
14. ABSTRACT see report					
15. SUBJECT TERMS					
16. SECURITY CLASSIFICATION OF:			17. LIMITATION OF ABSTRACT	18. NUMBER OF PAGES	19a. NAME OF RESPONSIBLE PERSON
a. REPORT unclassified	b. ABSTRACT unclassified	c. THIS PAGE unclassified	Same as Report (SAR)	13	

common view technique (Ref 1). The difference between UTC as provided by GPS and UTC(USNO) is usually less than 40 nsec (Ref 2). Use of the GPS has replaced LORAN-C as the transatlantic link between International Atomic Time (TAI) contribution, and permitted the inclusion of contributors to TAI in Asia and Australia (Ref 3). The usefulness of GPS, even in its unfinished state, has encouraged observers to make recommendations for its further improvement, and this paper will review progress in implementing those recommendations.

When the GPS is fully operational, GPS time (hereafter called Tgps) is to be related to UTC (Ref 4) and is to satisfy three specifications on accuracy:

1) Tgps is to be maintained to plus or minus one microsecond of UTC time, after leap seconds in UTC are removed. Specifically, since there are no leap seconds in Tgps, the number of leap seconds in UTC accumulated since the GPS epoch of 0h UTC on 6 January 1980, LS, is subtracted from the difference Tgps-UTC, so that the timing requirement becomes

$$T_{gps} - UTC - LS \leq 1 \text{ microsecond. (Ref 5)}$$

2) The offset Tgps - UTC is to be supplied to authorized users with error not to exceed 110 nanoseconds (nsec) standard deviation (1 sigma) (Ref 6). This requirement is to be tightened to 100 nsec in revised editions of GPS Interface Control Documents.

3) The Standard Positioning Service (C/A code) will be made available to all users, internationally, with a time equivalent 2 sigma accuracy of 250 nsec or better (Tgps), for a user in a known location (Ref 7).

Notice that specifications (2) and (3), above, imply that in times when selective availability is imposed, the authorized user can obtain UTC to better than 100 nsec (1 sigma), and the general user to 160 nsec (1 sigma) or better.

Of course, from a purely technical point of view, the above requirements are far from pressing the state of the art in time and frequency control. Thus, the Committee on Accuracy of Time Transfer in Satellite Systems reported:

The actual performance of the GPS system reference clock up to now is only mediocre for a cesium clock compared to what is seen in similar clocks at the USNO and in many terminals of the Defense Satellite Communications System (DSCS)...The main reason for the poor performance of the GPS ground clocks has been their adverse operational environment...

...a complete accounting of all clock rates and effects in the ground system with respect to the DOD Master Clock will improve performance...

...progress...may make it possible to improve significantly the accuracy of time transfer systems such as GPS. Yet such improvements might not be made because the stated requirements at the time may not be tight enough to make them obligatory...In the absence of tighter requirements the system would continue to operate at the current level despite the possibility for improvement. We think this would be a mistake...(Ref 8)

We will show in this paper that many, if not all, user concerns are being met. Tgps is in the process of becoming a much more stable measure of time than formerly, within the framework of DOD policy. According to this policy, requirements are not driven by capability, but by military necessity -- that is, not by US capability, but by the capability of its potential adversaries.

GPS TIME SCALE: CURRENT PERFORMANCE

Figures 1 and 2 illustrate the performance of Tgps with respect to UTC(USNO). Figure 1 shows the offsets UTC(USNO) - Tgps from the USNO @GPSV1 file, which employs three day smoothing on differences measured between UTC extracted from the navigation messages of all satellites and the USNO master clock, given the known position of the USNO receiver. Figure 2 shows the UTC(USNO) - Tgps rate differences from the same file. Thus, Figure 2 shows the first derivative of the function of Figure 1, except for the effects of data smoothing.

All the specified requirements described above were met. However, four events shown in Figure 1 caused the Tgps rate to change by large amounts, which would not have happened in an ideal system.

- 1) An abrupt steer was imposed on day of year 40 (9 February) by operations personnel, who observed that the Tgps rate was high and away from zero, and who believed that the proper action was to reverse the rate.

At a performance analysis working group meeting at the GPS Master Control Station on 11 March, a procedure was proposed by which the US Naval Observatory would calculate appropriate GPS steering parameters and post them in the USNO @GPSD9 file for operations use. This procedure eliminated large changes in the Tgps rate during April, May, and June.

- 2) On 26 June, the Colorado Springs Monitor Station (MS) clock was acting as the GPS master clock. On either 26 or 27 June, the master clock lost cesium control and reverted to quartz crystal. The problem was detected on Monday, 30 June. However, the role of master clock was switched from the Colorado to the Ascension MS after the clock failure and before its detection. By the time the problem was detected, the system software had mapped the defective clock rate to the new clock, and it was too late to recover the system by re-estimating clock states via the Kalman filter. The reason for the delay in detection of the problem is not fully known, but at present we do not believe it was due to any deficiency in GPS system software. Aerospace, IBM, and the JPO are continuing to examine both software and operator procedures to prevent similar events in the future.

The USNO/MCS interface succeeded in returning the Tgps - UTC rate to zero, but a series of communication line and monitor station hardware problems slowed the recovery. Steering was suspended during July because of the large number of master clock switches which these problems made necessary: 11 July, Ascension to Colorado; 14

July, Colorado to Hawaii; 21 July, Hawaii to Colorado; 22 July, Colorado to Kwajalein; July, Kwajalein to Colorado. The ECEST software is designed to preserve GPS time and rate against discontinuities during a master clock change, and the software worked very well. The only large change in Tgps rate between events (2) and (3) occurred around 15 to 20 July, due to normal random behavior of the Hawaii MS clock. (The MS clocks are not in a fully temperature controlled environment.)

3) The change in rate of the UTC(USNO) time scale of 12 nsec/day on 1 September is reflected in Figure 1. Due to operational problems at the Master Control Station (not clock related), it was not practical to steer GPS time to compensate for the UTC change until 9 September.

4) Considering the fact that Tgps was already within 300 nsec of the permitted 1000 nsec limit from the norm, and that another clock failure might put us over the limit, it was decided to steer by the maximum permissible rate to set a course toward zero.

In retrospect, we see that two improvements would eliminate sharp changes in Tgps rate and would permit steering of Tgps to within 50 nsec or less of the norm: first, a more stable master clock, with more dependable supporting hardware, which would eliminate the need for frequent clock switches; and second, clear procedures for controllers to follow and appropriate training for system operators, to minimize the effects of clock-related hardware failures.

USNO PRECISE TIME REFERENCE STATION

The U.S. Naval Observatory has installed a Precise Time Reference Station (PTRS) at the GPS Monitor Station (MS) at Falcon AFS, CO which can serve, under normal circumstances, as the GPS Master Clock. The system consists of an ensemble of cesium beam frequency standards (clocks) which are coordinated by a data acquisition and control system which is used for the monitoring of various systems and for the communication and exchange of data in order to allow the setting of a station clock which is kept synchronized in time and frequency to UTC(USNO) by the control of a phase-microstepper (Ref. 9). The PTRS will serve as an interim system pending a Hydrogen Maser Advanced Clock System (HMACS) which will constitute the Operational Control System Advanced Clock to be installed at the GPSMS, Falcon AFS, CO by the Naval Research Laboratory (NRL).

The present design of the Operational Control System (OCS) employs two high performance Cesium Beam Frequency Standards. One drives the receiving equipment, while the other is used as a spare. The hydrogen maser system will be based on the design of the Precise Time Reference Station used by the USNO, which acts as a logical intermediate system between the present system and the forthcoming Hydrogen Maser Advanced Clock System.

Various forms of timing data are obtained by the PTRS. It consists of measured differences of various pairs of clocks in the local ensemble and observed differences between the local reference clock and GPS time as determined through a single channel time transfer receiver. Through common-view measurements (Ref. 10) with USNO, the

drift rate and offset of the local reference clock at the GPSMCS with respect to UTC(USNO) can be determined. Once these parameters are known adjustments can be made to the phase-microstepper controlling the local reference clock. These adjustments can be made automatically by the USNO ADS or provision can be made for local station personnel to control the setting of the phase-microstepper because of security considerations.

As of 21 Dec 1986, an algorithm to automatically control and steer a local reference clock to UTC(USNO) has been implemented within the PTRS at Falcon AFS. Figure 3 shows the results of that steering. After automatic steering started, an anomalous frequency change occurred in the local cesium frequency standard driving the PTRS Local Reference Clock. The length of time it took the algorithm to compensate for this change in frequency was long. The compensation could have been done much more quickly, but the algorithm takes into consideration the operational constraints that are currently imposed on the steering of GPS which were mentioned earlier.

Communication between the USNO and the GPSMCS is essential for exchange of data. The daily exchange of data is sufficient to assure adequate control of the local reference clock. In the event that there is loss of communication, then the local ensemble is used as a flywheel to extrapolate UTC(USNO). The ensemble also monitors the short-term performance of the local set of clocks. This allows the automatic identification of poorly performing clocks -- thus improving system performance.

CONTROL THEORY EQUATIONS AND SIMULATED PERFORMANCE

The block diagram shown in Figure 4 illustrates the system. Our goal is to set the filter function parameters in such a way as to drive the time difference to zero between the output of the micro-stepper and the UTC(USNO MC) as seen at the Operational Control Segment (OCS) via the GPS common-view time-transfer technique. This time difference is given by

$$X(t) = X_G(t) + X_s(t) - (X_m(t) + X_n(t)) \quad (1)$$

In addition the parameters need to be set in such a way as to be insensitive to system disturbances, and such that changes in frequency of the micro-stepper output are less than $2 \times 10^{-14}/\text{day}$, which is the OCS GPS requirement to prevent the Kalman filter from propagating errors which may unduly perturb the navigation solutions for the users.

If $Y(t-\tau)$ is the last frequency correction value set in the micro-stepper, then a filtered estimate of an update frequency correction is given by

$$Y(t) = \frac{m}{m-1} (Y(t-\tau) + (X(t) - X(t-\tau))/\tau) + 1 * X(t)/\tau \quad (2)$$

where the first term drives the syntonization and the second term drives the synchronization. Tau " τ " is the nominal time interval between measurements -- in our case it is typically one day. All we need to do is pick proper values of m and l for the range of random variations we may encounter in the master clock, the OCS clock and in the common-view the new output time added by the micro-stepper is given by

$$\chi_s(t+\tau) = \chi_s(t) - Y(t)/2 \quad (3)$$

The common-view time transfer noise has been measured to be a white phase modulation (PM) process with a standard deviation of about 1 to 2 ns. The random variations of the master clock and the OCS clock have been measured to be a flicker noise FM like process in the range of 1 to 4×10^{-14} for $\sigma_y(\tau)$, and $1 \text{ day} \leq \tau \leq$ a few weeks.

Figures 5 and 6 are the measured and simulated frequency stabilities. We picked a nominal worst case and a nominal best case for simulation purposes. The worst case conditions are plotted in Figures 7 and 8 for the frequency stabilities of the micro-stepper's steered output, $x(t)$, and of the time amounts to less than 2×10^{-14} , which is the design goal; and the standard deviation of the residuals around a linear-least-squares fit to the time difference output amounted to 9ns.

Figures 9 and 10 are the corresponding figures for the nominal best case simulation. In this case the day to day rms steering correction amounts to 0.8×10^{-14} , and the standard deviation of the residuals around a linear-least-squares fit to the time difference output amounted to 3ns.

Figure 11 illustrates the transient response to a beginning time and frequency error. Through simulation and an empirical approach to setting the parameters, we were able to find a single set which gave the above performance for the nominal worst case, the nominal best case and for the transient response. The values we found were $m = 2.5$ and $l = 0.4$ with $\tau = 1 \text{ day}$.

CONCLUSIONS

In order to improve GPS for the global distribution of precise time, a number of modifications to existing procedures have been proposed and are in the process of being implemented. Improved timekeeping hardware at the Master Control Station will minimize switching of the designated GPS master clock among the various monitor stations. This will help reduce the effect of master clock switching on steering when it is being implemented by software techniques. The application of control theory to time steering procedures will dampen any sudden changes in GPS master clock rate. The users of precise time will benefit from these improvements in timing performance because the time signals from GPS will be modeled with a higher degree of reliability than previously.

REFERENCES

- 1) "Accuracy of Time Transfer in Satellite Systems", CATTISS (Committee on Accuracy of Time Transfer in Satellite Systems), National Academy Press, 1986, p25.
- 2) Klepczynski, W. J. and Kingham, K. A., "Time From GPS", Proceedings of the First International Symposium on Precise Positioning with the GPS, US Department of Commerce, National Oceanic and Atmospheric Administration, May 1985, p879f.
- 3) Comite Consultatif Pour la Definition de la Seconde, Bureau International des Poids

et Mesures, Rapport de la 10e Session, pS45.

- 4) "Precise Time and Time Interval (PTTI) -- Planning, Coordination, and Control", Department of Defense Directive 5160.51, 14 June 1985.
- 5) "Navstar GPS Control Segment / US Naval Observatory Time Transfer Interfaces", Interface Control Document- GPS-202, 21 November 1984, p10.
- 6) idem, p23.
- 7) Letter, Wayne H. Jones, Colonel, USAF, to Dr. Giacomo, Bureau International des Poids et Mesures, 3 July 1985.
- 8) *op. cit.*, Ref 1, pp 25, 41.
- 9) Wheeler, P.J., "Automation of Precise Time Reference Stations (PTRS)," 41-52, Proceedings of the 15th Annual PTTI Applications and Planning Meeting, 1983.
- 10) Allan, D.W. and Weiss, M.A., 1985, "Accurate Time and Frequency Transfer Driving Common-View of a GPS Satellite," Proceedings of the 34th Annual Frequency Control Symposium.

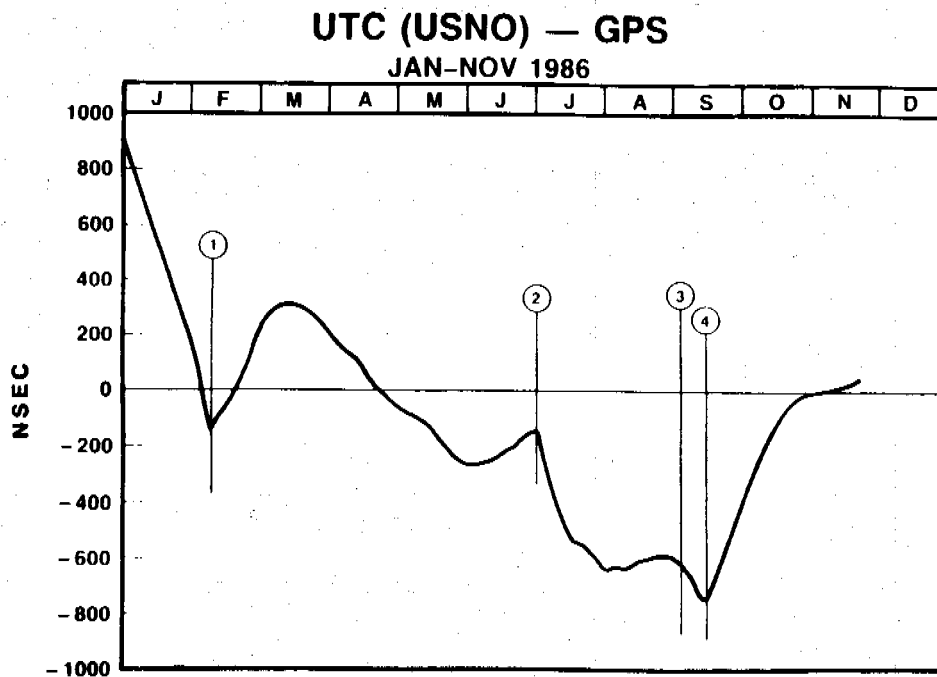

Figure 1 - Differences (in nanoseconds) between UTC(USNO) and GPS Time. Data has been filtered using three day smoothing.

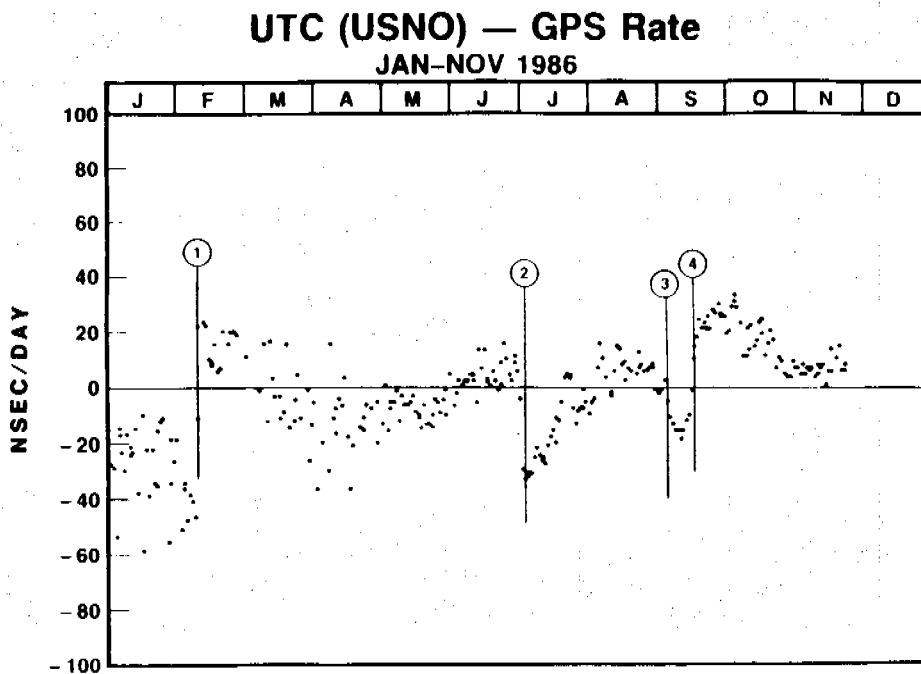

Figure 2 - Differences (in nanoseconds/day) between the rate of UTC(USNO) and GPS Time. The data represents the first derivative of the data in Figure 1, except for the effects of smoothing.

UTC(USNO) - PTRS(Local Reference)

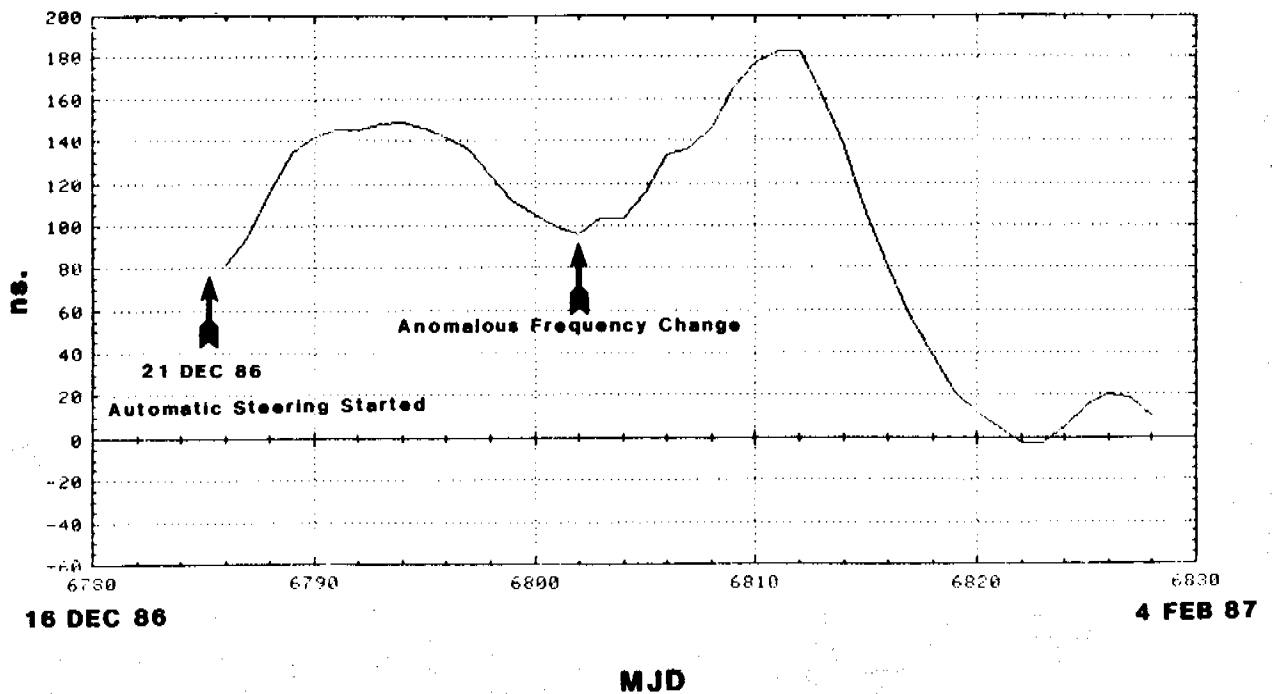

Figure 3 - Differences between UTC(USNO) and the Local Reference Clock of the USNO Precise Time Reference Station (PTRS) in nanoseconds.

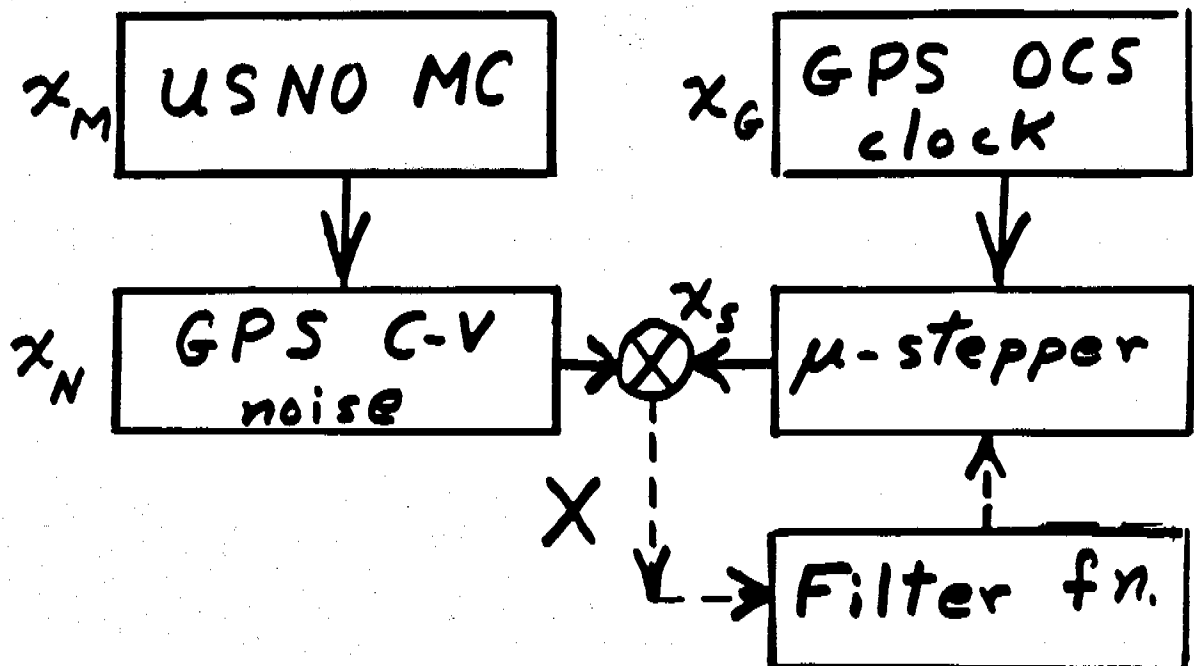

Figure 4 - Block Diagram of the Control Theory Steering Procedures.

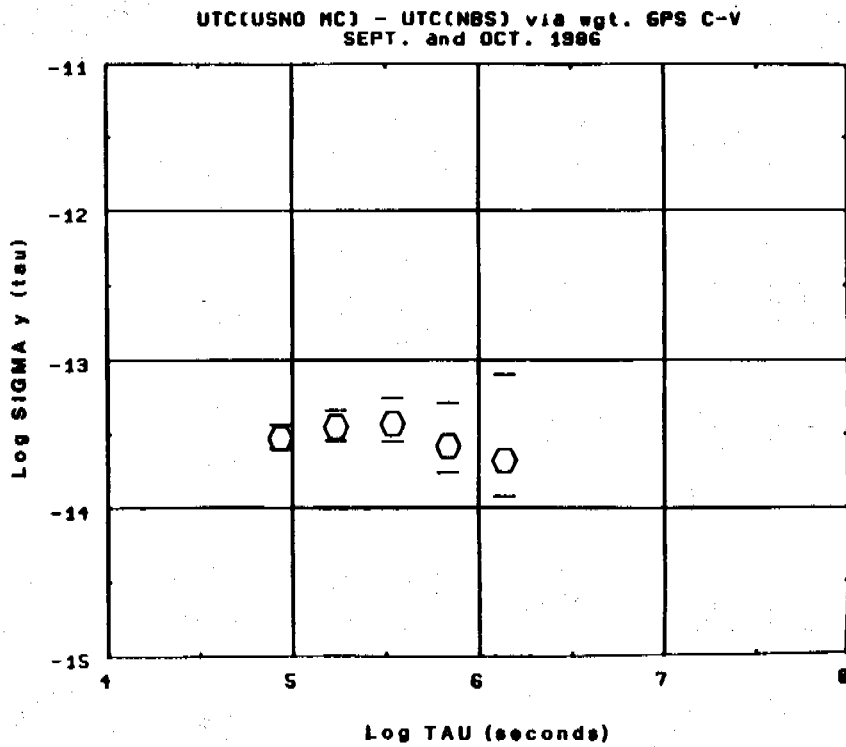

Figure 5 - Measured Frequency Stabilities between UTC(USNO, MC) and UTC(NBS).

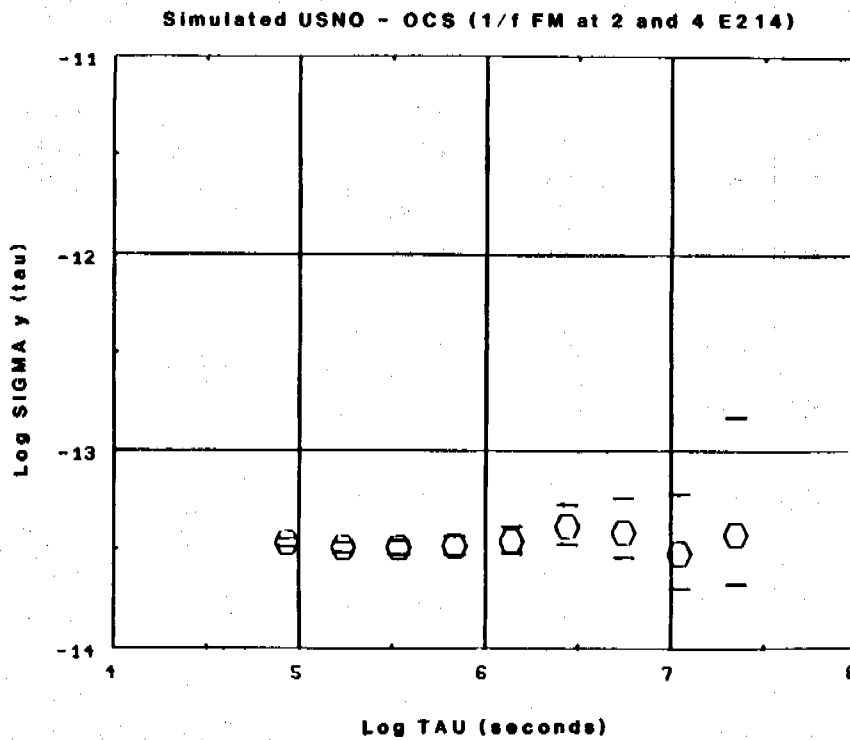

Figure 6 - Simulated Frequency Stabilities between UTC(USNO) and GPS Time.

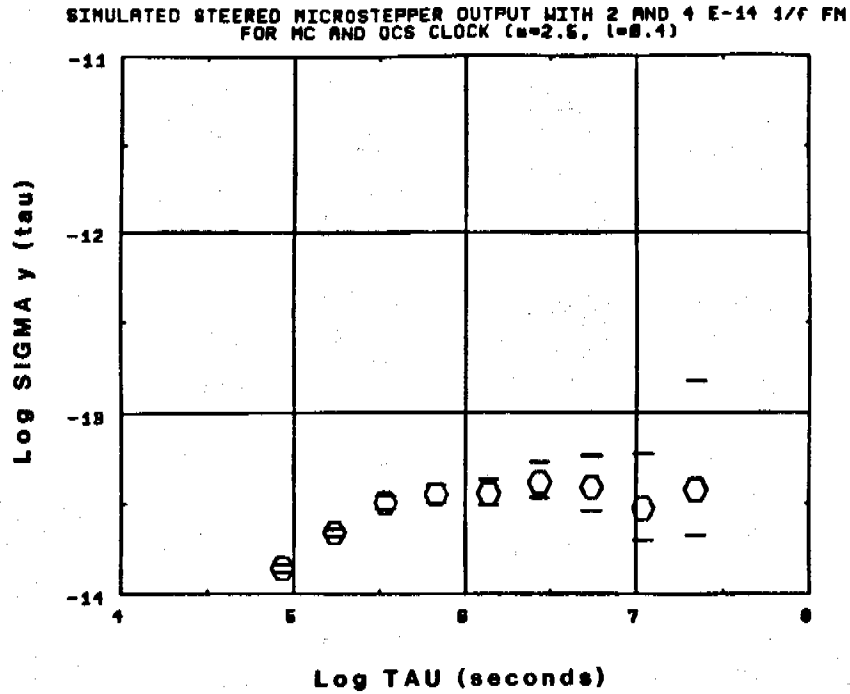

Figure 7 - Frequency Stability of the Steered Microstepper Output under worst case conditions.

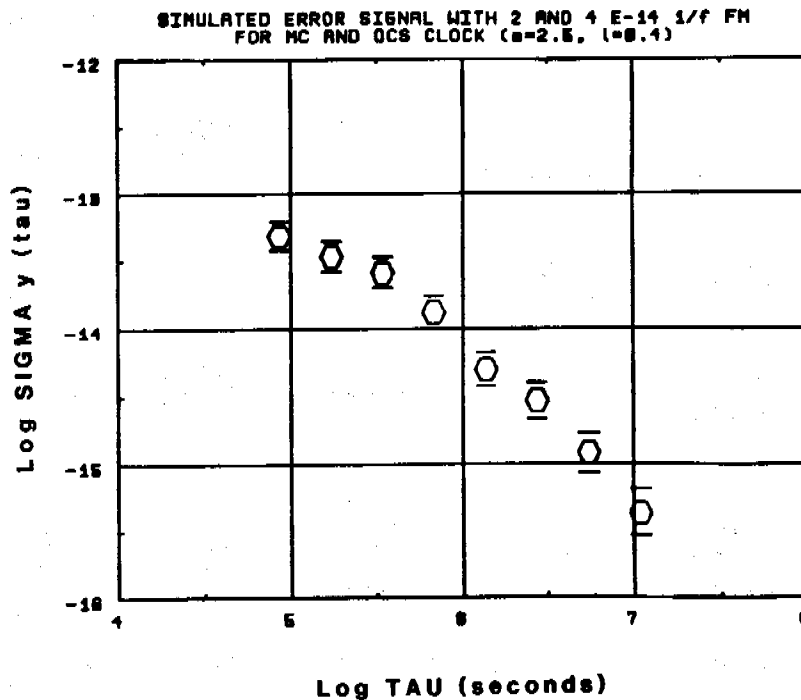

Figure 8 - Simulated Error Signal between UTC(USNO) and GPS Time for 1/f FM noise of 4×10^{-14} (worst case condition).

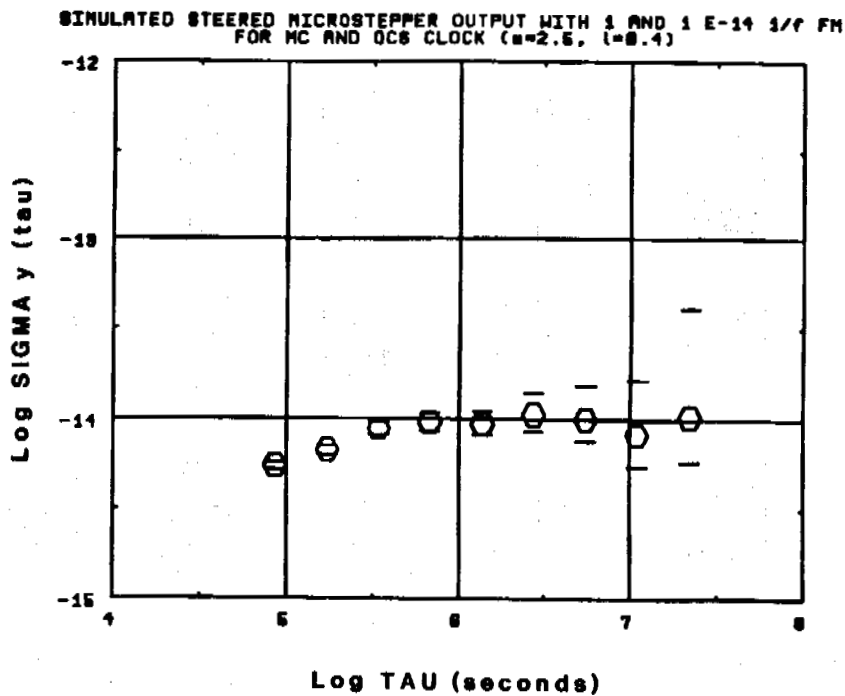

Figure 9 - Frequency Stability of the Steered Microstepper Output under best case conditions.

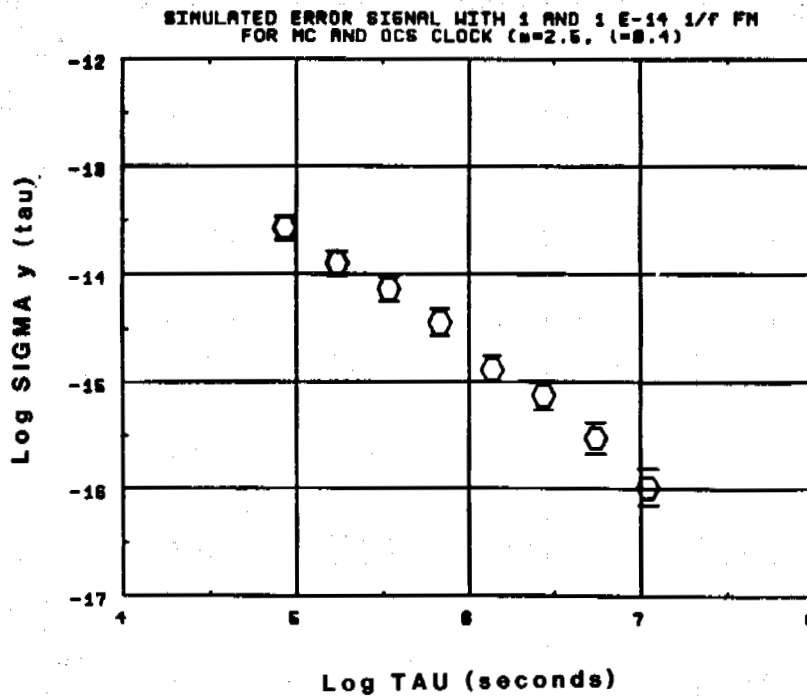

Figure 10 - Simulated Error Signal between UTC(USNO) and GPS Time for 1/f FM noise of 1×10^{-14} (best case condition).

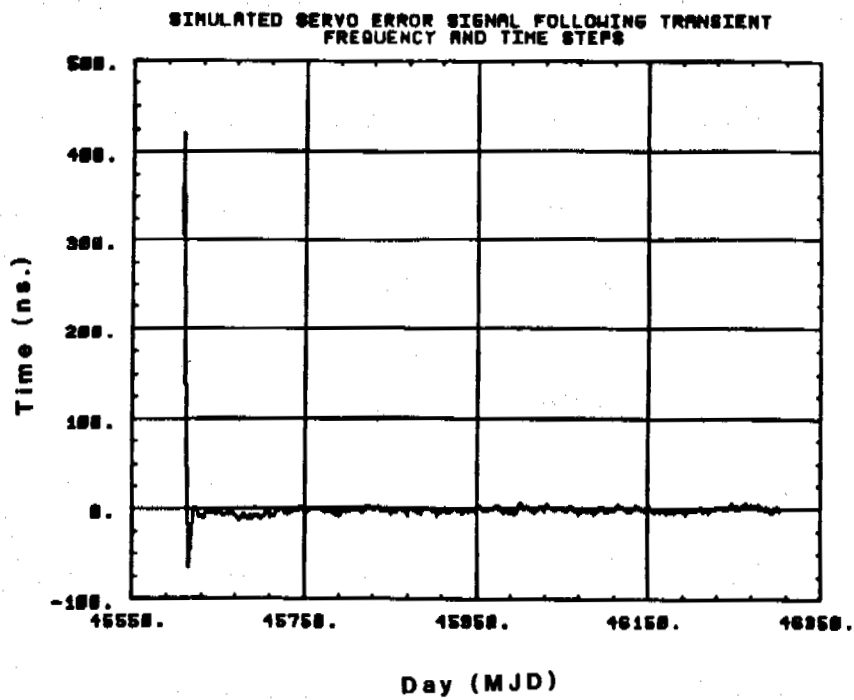

Figure 11 - Simulated response to a beginning time step and a frequency error.